



*It's not a mirror,  
it's a Face Recognition Terminal*

## Face ID 4d FMM

Face Recognition System for  
Door Access & Time Attendance



FingerTec Face ID 4d, the all-new powerful facial recognition terminal from FingerTec provides solid identity verification through its contactless biometrics technology, recognizing a face in mere seconds for accurate door access solution. Loaded with Face Biobridge VX 7.0, the latest of face recognition algorithm, detecting facial features during enrollment and verification is made quicker and more accurate, and with the high-resolution camera and infrared feature, face detection is possible even under minimal light. Customized for function, the device comes prepared with door access usage. Face ID 4d is an ideal solution that is suitable for small and medium enterprises, as well as those in need of a reliable, contactless solution.



### Contactless Identification

With Face ID 4d, all you need is one look, and you're ready to go. Facial recognition makes it easy for you to verify yourself without having to free your hands.

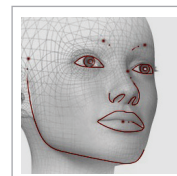

### Revolutionary Face Technology

With the latest VX 7.0 face recognition algorithm, face detection during verification and enrollment is now quicker and more accurate.



### Multi-Verification Methods

You have multiple verification options with Face ID 4d. Verify yourself using face, card, or even by password.

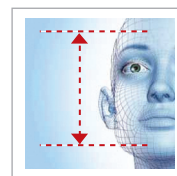

### Ergonomically Designed

Face ID 4d's design is engineered specifically to facilitate easy positioning and alignment of your face for an easy and hassle-less verification.



### Easy Communication Methods

Sync Face ID 4d with a PC using one of these easy-to-use communication methods: TCP/IP or USB flash disk.

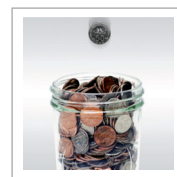

### Value for Money

Face ID 4d was designed to be economical so that you are able to implement FingerTec solutions at a lower cost. We believe that when it comes to business and security, there should be no compromise.



### Get Your Extra Features Here

Full colour touch screen, short messaging, work codes, photo display after verification. These are among our many additional features that you get with Face ID 4d.







### Manage Your Data Easily

Administration is easy with the Ingress software application. Ingress allows you to remotely manage door activity of all connected terminals, while containing time attendance functions for attendance monitoring.

## WEB LINK

**Product**  
<https://product.fingertec.com/faceid4d.php>

-  Quick Start Guide
-  Installation Guide
-  User Guide
-  Video Guide
-  Technical Tips

**Ingress Software**  
<http://info.fingertec.com/ingress>

## LAYOUT PLAN

### System Communication

*for illustration only*

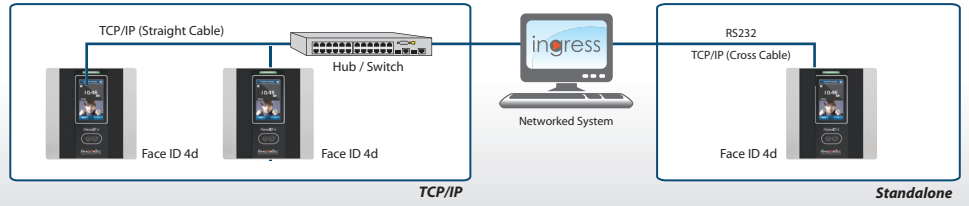

### Installation Diagram

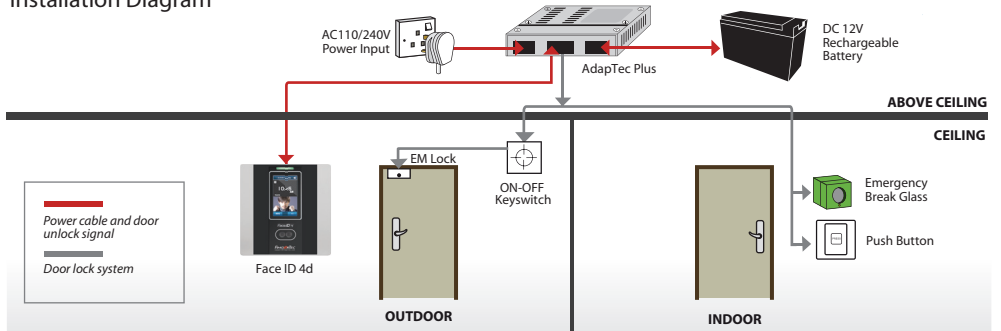

## SPECIFICATIONS

<b>MODEL</b>	Face ID 4d
<b>SURFACE FINISHING</b>	Acrylonitrile butadiene styrene/polycarbonate blend
<b>TYPE OF SCANNER</b>	High resolution infrared camera
<b>MICROPROCESSOR</b>	1.2Ghz
<b>MEMORY</b>	128 MB RAM & 256 MB Flash
<b>ALGORITHM</b>	Face BioBridge VX 7.0
<b>PUSH TECHNOLOGY</b>	Yes
<b>DIMENSION (L X W X H), mm</b>	151 x 26 x 150
<b>STORAGE</b>	
Face templates	3000
Cards	10000
Transactions	200000
<b>ENROLLMENT &amp; VERIFICATION</b>	
Methods	Face (1:1, 1:N), card & password
Verification time (sec)	< 1
FAR (%)	< 0.01
FRR (%)	< 0.1
<b>CARD TECHNOLOGY</b>	
RFID: 64-bit, 125kHz	Yes
MIFARE: MFIS50/S70, 13.56MHz	Made to order
<b>COMMUNICATIONS</b>	
Method	TCP/IP, USB Host (Optional WiFi)
Baud rates	9600, 19200, 38400, 57600, 115200
<b>OPERATING ENVIRONMENT</b>	
Temperature (°C)	0 ~ 45
Humidity (%)	20 ~ 80
Power input	12V DC 3A
<b>TIME ATTENDANCE</b>	
Siren	Built-in (Optional external)
Work codes	Yes
Fast transaction checking	Yes
<b>MULTIMEDIA</b>	
Greeting voice	Yes
Display	2.8" 65k color TFT touch screen panel
Photo ID	Yes
Short messaging	Yes
Photo capture	Yes
Day light saving timer	Yes
<b>ACCESS CONTROL</b>	
EM lock driving output	12V DC / relay output
Alarm output	NO/NC
Door sensor	Yes
<b>VOICE / DISPLAY LANGUAGE (TERMINAL)</b>	English (Standard), Arabic, Chinese (Simplified/Traditional), Indonesian, Portuguese (Portugal), Spanish. Other languages are available upon request.
<b>SOFTWARE LANGUAGE</b>	English (Standard), Arabic, Bulgarian, Chinese (Simplified/Traditional), French, German, Hindi, Indonesian, Kurdish, Malay, Persian, Portuguese, Russian, Spanish, Thai, Vietnamese

*NOTE: Specifications are subject to change. Check <http://product.fingertec.com> for latest product information.*

Authorized Reseller:



### Packaging

Dimension (mm) : 298 (L) x 123 (W) x 222 (H)  
 Weight : 1.55 kg



**FINGERTEC**  
[www.fingertec.com](http://www.fingertec.com)  
 © 2020 Timetec Computing Sdn Bhd. All rights reserved.